

GLORY ASVM II

3-5.5KVA

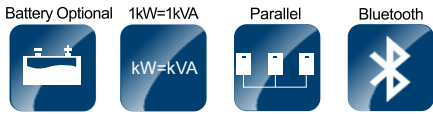

Product Snapshot

- Model: 3KW/3.5KW/5.5KW
- Nominal Voltage: 230VAC
- Frequency Range: 50Hz/60Hz

Key Features:

- Pure sine wave solar inverter
- Output power factor 1
- Parallel operation up to 9 units
- High PV input voltage range
- Battery independent design
- Built-in 100A MPPT solar charger
- Battery equalization function to optimize battery performance and extend lifecycle



Hybrid Operation

With battery connected

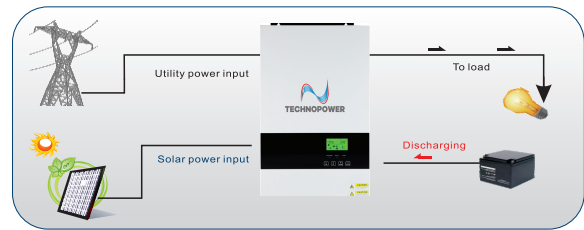
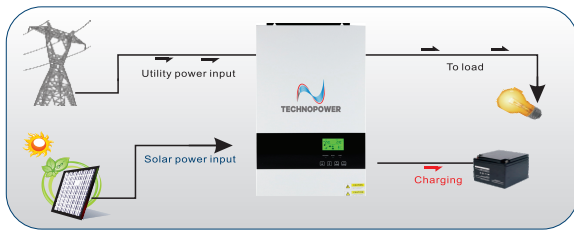

Without battery connected

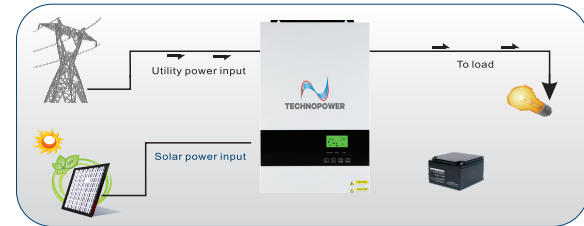
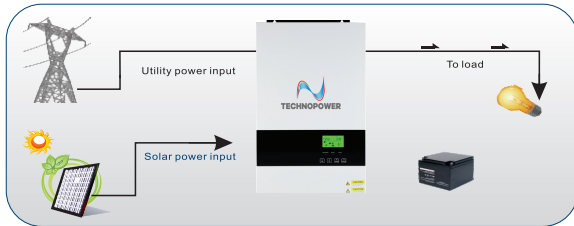

■ Single phase output up to 49.5KW using 9 units

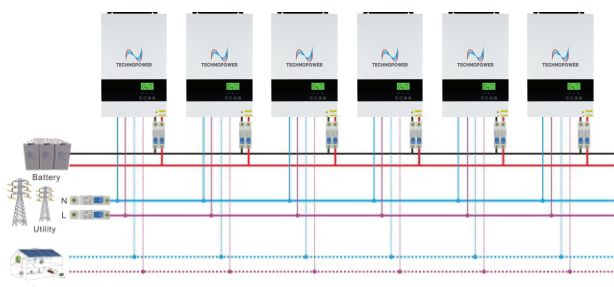

■ Three phase output using either 3 units(16.5KW)or max 9 units(49.5KW)

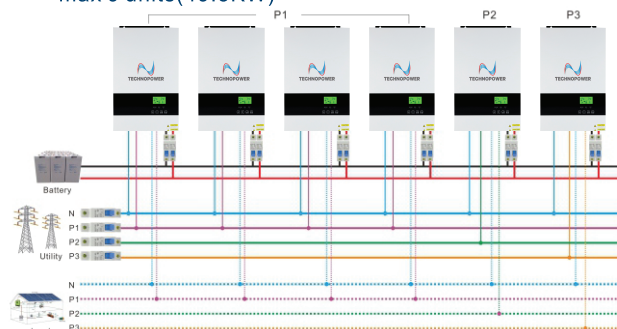

GLORY ASVM II

Wall Mounted Integrated Solar Inverter Technical Specification Built-in MPPT Solar Controller

MODEL	GLORY ASVM II 3000-24	GLORY ASVM II 3500-24	GLORY ASVM II 5500-48
Rated Power	3000VA / 3000W	3500VA / 3500W	5500VA / 5500W
INPUT			
Voltage	230 VAC		
Selectable Voltage Range	170-280 VAC (For Personal Computers) ; 90-280 VAC (For Home Appliances)		
Frequency Range	50 Hz/60 Hz (Auto sensing)		
OUTPUT			
AC Voltage Regulation (Batt. Mode)	230VAC ± 5%		
Surge Power	6000VA	7000VA	11000VA
Efficiency (Peak)	up to 93.5%		
Transfer Time	10 ms (For Personal Computers) ; 20 ms (For Home Appliances)		
Waveform	Pure sine wave		
BATTERY			
Battery Voltage	24 VDC		48 VDC
Floating Charge Voltage	27 VDC		54 VDC
Overcharge Protection	33 VDC		63 VDC
SOLAR CHARGER & AC CHARGER			
Maximum PV Array Open Circuit Voltage	500 VDC		500 VDC
Maximum PV Array Power	5500 W		5500 W
MPPT Range @ Operating Voltage	120~450 VDC		120~450 VDC
Maximum Solar Charge Current	100 A		100 A
Maximum AC Charge Current	80 A		80 A
Maximum Charge Current	100 A		100 A
PHYSICAL			
Dimension, D x W x H (mm)	550x420x225		
Net Weight (kgs)	11.3	11.5	12.1
Communication Interface	USB/RS232		
ENVIRONMENT			
Humidity	5% to 95% Relative Humidity (Non-condensing)		
Operating Temperature	-10°C to 50°C		
Storage Temperature	-15°C to 60°C		

Note: Product specifications are subject to change without further notice.
SSI20-0000012-04